

Mitutoyo

PRECISION TOOL SALE

FALL 2019



Effective October 1st - December 20th 2019 while quantities last. Some items may not be exactly as shown & may be seen with extra accessories not included in the promo.



FOLLOW US • LIKE US

Distributed By:

2 Micrometers

MECHANICAL MICROMETERS



Graduation	Range	Order No.	Promo	Calibration
.0001"	0-1"	103-135	\$127.30	\$41.00
.0001"	2-3"	103-217	\$168.15	\$41.00
.0001"	3-4"	103-218	\$183.35	\$41.00
.0001"	4-5"	103-219	\$200.45	\$41.00
.0001"	5-6"	103-220	\$216.60	\$41.00

*.0001 reading is obtained with vernier

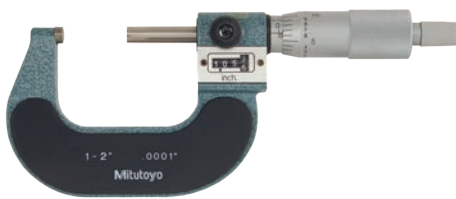

Graduation	Range	Order No.	Promo	Calibration
.0001"	1-2"	193-212	\$229.08	\$41.00

*.0001 reading is obtained with vernier

Please view our online catalogue for the full list of features, accessories and specifications



MICROMETER SETS

Graduation	Range	Order No.	Promo	Calibration
.0001"	0-3"	103-922	\$436.05	\$175.00
.001"	0-3"	103-929	\$386.65	\$175.00

*please view our catalog for specifics



MICROMETERS HEADS

Accuracy	Range	Order No.	Promo	Calibration
±.0001"	0 - .5"	148-112	\$72.68	\$80.00
±.0001"	0-.25"	148-353	\$75.44	\$80.00



QUANTUMIKE

Resolution	Range	Order No.	Promo	Calibration
.00005"/0.001mm	1-2"/25.4 - 50.8mm	293-186-30	\$300.20	\$41.00



DIGIMATIC MICROMETERS

Resolution	Range	Order No.	Promo	Calibration
.00005"/	0-1"/0-25.4mm	293-344-30	\$212.80	\$41.00
0.001mm	1-2"/25.4-50.8mm	293-345-30	\$277.40	\$41.00



BACK-PLUNGER DIAL INDICATOR

Graduation	Range	Dial Reading	Order No.	Promo	Calibration
.001"	.2"	0-25-0	1167T	\$156.40	\$41.00

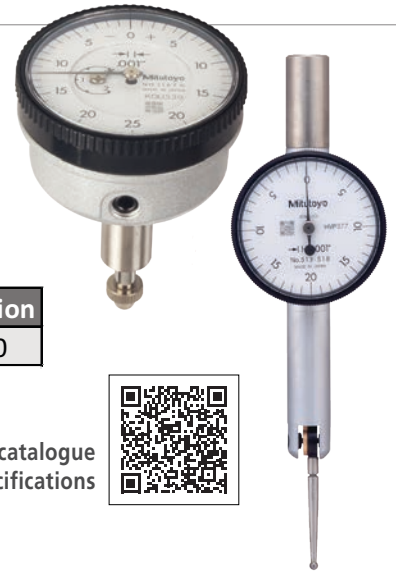

POCKET DIAL TEST

Graduation	Range	Dial Reading	Order No.	Promo	Calibration
.001"	.04"	0-20-0	513-518	\$154.85	\$41.00



DIAL INDICATORS

Please view our online catalogue for the full list of features, accessories and specifications



SERIES 2

Graduation	Range	Dial Reading	Order No.	Promo	Calibration
0.01mm	10mm	0-100	2046S	\$111.15	\$41.00
.001"	1"	0-100	2416SB	\$121.44	\$41.00
.001"	2"	0-100	2424S-19	\$253.65	\$41.00
.0001"	.05"	0-5-0	2923S-10	\$184.30	\$41.00

SERIES 3

Graduation	Range	Dial Reading	Order No.	Promo	Calibration
.001"	1"	±0-100	3416S	\$179.40	\$41.00

DIAL TEST

Graduation	Range	Dial Reading	Order No.	Promo	Calibration
0.002mm	0.2mm	0-100-0	513-405-10T	\$228.00	\$41.00
.0005"/0.01mm	.03"/0.7mm	0-15-0/0-35-0	513-406-10E	\$176.64	\$41.00
.0005"	.03"	0-15-0	513-412-10T	\$257.45	\$41.00



DIGIMATIC INDICATORS



ABSOLUTE DIGIMATIC ID-C

Resolution	Range	Order No.	Promo	Calibration
.00005"/.0001"/.0005" 0.001/ 0.01mm (Selectable)	.5"/12.7mm	543-342B*	\$554.80	\$41.00
0.0005"/0.001mm	.5" / 12.7mm	543-392B	\$509.20	\$41.00

*without IP42 data output

ABSOLUTE DIGIMATIC ID-S

Resolution	Range	Order No.	Promo	Calibration
0.0005" / 0.01 mm	.5" / 12.7 mm	543-783	\$212.80	\$41.00
0.0001" / 0.001 mm	.5" / 12.7 mm	543-793B	\$319.24	\$41.00



4 Indicators

DIGIMATIC INDICATORS

ABSOLUTE DIGIMATIC ID-H

Resolution	Range	Order No.	Promo	Calibration
.00002", .00005", .0001", 0.0005mm, 0.001mm	2.4" / 60.9mm	543-564A	\$1,217.16	\$41.00



ABSOLUTE DIGIMATIC ID-B

Resolution	Range	Order No.	Promo	Calibration
.0005" / 0.01mm	.22" / 5.6mm	543-581	\$461.84	\$41.00



Please view our online catalogue for the full list of features, accessories and specifications

ABSOLUTE® SPC



CABLES

SPC CABLE

Description	Order No.	Promo
Cable, SPC, Coolant Proof - 1 Meter	05CZA624	\$96.60



USB, INPUT TOOL

Description	Order No.	Promo
INPUT TOOL, USB	264-016-10	\$229.08

ABSOLUTE DIGIMATIC HEIGHT GAUGE

Resolution	Range	Order No.	Promo	Calibration
.0005" (0.01mm) [.0002" (0.005mm) Switchable]	0-18" / 0-450mm	192-671-10	\$2,434.32	\$147.00

SPC



ABSOLUTE® SPC



DIGIMATIC HEIGHT GAUGES

Resolution	Range	Order No.	Promo	Calibration
.0005" / 0.01mm	0 - 24" / 0 - 600mm	570-314	\$1,354.70	\$227.00



CALIPERS

DIAL CALIPERS

Graduation	Range	Order No.	Promo	Calibration
.001"	0-6"	505-736	\$214.36	\$41.00
.001"	0-8"	505-741	\$191.36	\$54.00
.001"	0-12"	505-746	\$344.85	\$68.00

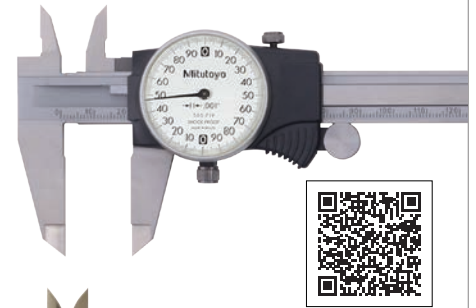

VERNIER CALIPERS

Graduation	Range	Order No.	Promo	Calibration
.001" LS, 1/128" US	0 - 6"	530-105	\$94.05	\$41.00
0.02mm LS, .001" US	0 - 200mm / 0 - 8"	530-118	\$127.30	\$54.00
0.05 mm LS, 1/128" US	0 - 150mm / 0 - 6"	531-122	\$128.80	\$41.00

*Graduation for upper and lower

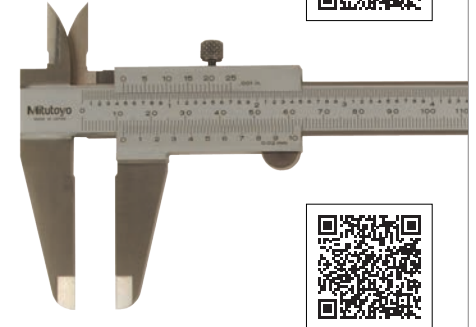

MYCAL-LITE

Range	Order No.	Promo	Calibration
0-6" / 0-150 mm	700-113-10	\$134.32	\$41.00



ABSOLUTE DIGIMATIC CALIPER

Resolution	Range	Order No.	Promo	Calibration
.0005" / 0.01mm	0 - 8" / 0 - 200mm	500-164-30*	\$450.80	\$54.00
.0005" / 0.01mm	0 - 4" / 0 - 100mm	500-170-30	\$206.15	\$41.00
.0005" / 0.01mm	0 - 6" / 0 - 150mm	500-178-30	\$308.20	\$41.00
.0005" / 0.01mm	0 - 24" / 0 - 600mm	500-506-10	\$1,083.95	\$120.00
.0005" / 0.01mm	0-8" / 0-200mm	500-197-30*	\$270.75	\$54.00

*without SPC data output

ABSOLUTE[®] SPC



COOLANT-PROOF CALIPERS

Resolution	Range	Order No.	Promo	Calibration
.0005"/0.01mm	0-8"/0-200mm	500-753-20	\$337.25	\$54.00
.0005"/0.01mm	0-6"/0-150mm	500-752-20	\$250.80	\$54.00



IP67



6 Calipers

ABSOLUTE CARBON-FIBER CALIPER

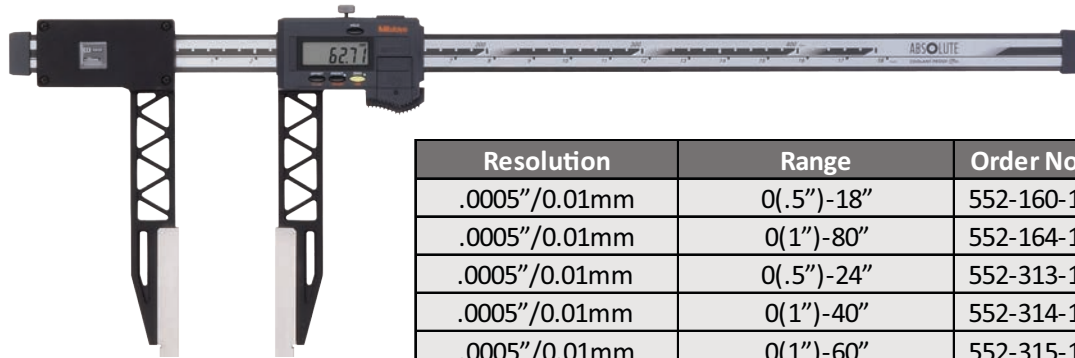

Resolution	Range	Order No.	Promo	Calibration
.0005"/0.01mm	0(.5")-18"	552-160-10	\$1,680.84	\$94.00
.0005"/0.01mm	0(1")-80"	552-164-10	\$4,393.00	\$333.00
.0005"/0.01mm	0(.5")-24"	552-313-10	\$1,229.12	\$120.00
.0005"/0.01mm	0(1")-40"	552-314-10	\$2,190.52	\$174.00
.0005"/0.01mm	0(1")-60"	552-315-10	\$2,620.16	\$254.00

*(): Minimum dimension in ID measurement

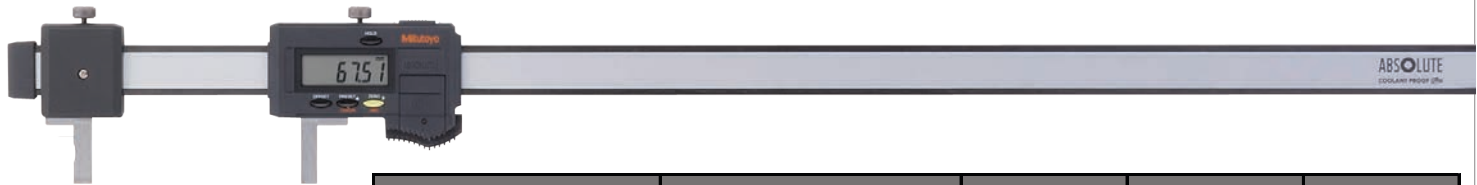

Accuracy	Range	Order No.	Promo	Calibration
±.002"	0 - 24" / 0 - 600mm	552-192-10	\$1,090.20	\$120.00

* Attachments required. See below table for choices.

ACCESSORIES

Description	Order No.	Promo
Attachment Clamps (models up to 24")	914053	\$231.84
Attachment Clamps (models up to 24")	914054	\$203.32
Centerline Attachment (Inch)	914056	\$259.44
Pointed ID Attachment (Inch)	914058	\$331.20

Description	Order No.	Promo
Standard Type Interchangeable Jaw (Right)	07cza044	\$309.12
Standard Type Interchangeable Jaw (Set)	07cza056	\$356.04
Centerline Type Interchangeable Jaw (Set)	07cza057	\$396.52
Inside Point Type Interchangeable Jaw (Set)	07cza059	\$396.52



RADIUS GAUGE

Composition of Leaves	Order No.	Promo
26 Leaves*	186-906	\$183.08



*Please view our catalog for specifics



PITCH GAUGE

Composition of Leaves	Range	Order No.	Promo
18 Leaves*	0.4-7mm	188-121	\$33.25

*Please view our catalog for details

THICKNESS GAUGES

Blade Length	Range	Type of Blade	Order No.	Promo
150mm	0.05 - 1mm	Straight 13mm width	184-303S	\$94.05

*28 leaves, please view our catalogue for details

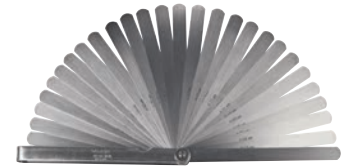

Graduation	Range	Order No.	Promo	Calibration
0.01mm	0 - 10mm	7301	\$149.04	\$54.00



ABSOLUTE[®] SPC



DIGITAL THICKNESS GAUGES

Graduation	Range	Order No.	Promo	Calibration
.0005"/0.01mm	0 - .4"	547-300S	\$519.80	\$54.00



ABSOLUTE DIGIMATIC DEPTH GAUGE

Resolution	Range	Order No.	Promo	Calibration
.0005" / 0.01mm	0 - 12" / 0 - 300mm	571-213-10	\$591.85	\$120.00



BORE GAUGES



Range	Order No.	Promo	Calibration
18 - 35mm	511-721	\$493.12	\$94.00
50 - 150mm	511-723	\$503.24	\$94.00
1.4 - 2.5"	511-742	\$412.16	\$94.00
2 - 6.0"	511-743	\$457.24	\$94.00
0.7 - 6.0"	511-932	\$1,233.10	\$94.00

*Please view our catalogue for specifics

RULE



Description	Order No.	Promo
Steel Rule Flexible Wide 6"	182-211	\$24.70
Steel Rule Flexible Wide 12"	182-208	\$23.75
Steel Rule Flexible Wide 12"	182-222	\$33.25

MAGNETIC STANDS

Description	Order No.	Promo
Magnetic Stand	7010SN	\$103.55
Universal Magnetic Stand	7033B	\$238.45



CLEAR LOUPE

Magnification	Order No.	Promo
10X	183-302	\$23.75



CENTER FINDER

Shank Diameter	Order No.	Promo
3/8"	050103	\$32.30



Please view our online catalogue for the full list of features accessories and specifications



BUILD YOUR OWN DIGITAL READOUT PACKAGE

SAVE 5% WITH A MINIMUM PURCHASE

With Minimum Purchase	Description	Code	Without Min. Purchase	With Min. Purchase
One AT715 Linear Scale	KA- Counter (2-axis)	174-183A	\$734.00	\$697.30
One KA-200 Counter (2 or 3 axis)	KA- Counter (3-axis)	174-185A	\$1,080.00	\$1,026.00
	1 pc. Linear Scale	Your choice	Please review the table below for pricing	

Effective Range	Order No.	Without Min. Purchase	With Min. Purchase
6" / 150mm	539-802	\$370.00	\$351.50
8" / 200mm	539-803	\$374.00	\$355.30
10" / 250mm	539-804	\$374.00	\$355.30
12" / 300mm	539-805	\$374.00	\$355.30
14" / 350mm	539-806	\$378.00	\$359.10
16" / 400mm	539-807	\$383.00	\$363.85
18" / 450mm	539-808	\$390.00	\$370.50
20" / 500mm	539-809	\$394.00	\$374.30
24" / 600mm	539-811	\$401.00	\$380.95
28" / 700mm	539-813	\$409.00	\$388.55
30" / 750mm	539-814	\$415.00	\$394.25
32" / 800mm	539-815	\$418.00	\$397.10
36" / 900mm	539-816	\$456.00	\$433.20
40" / 1000mm	539-817	\$474.00	\$450.30
44" / 1100mm	539-818	\$538.00	\$511.10
48" / 1200mm	539-819	\$603.00	\$572.85
52" / 1300mm	539-820	\$669.00	\$635.55
56" / 1400mm	539-821	\$731.00	\$694.45
60" / 1500mm	539-822	\$811.00	\$770.45
64" / 1600mm	539-823	\$909.00	\$863.55
68" / 1700mm	539-824	\$1,004.00	\$953.80
72" / 1800mm	539-825	\$1,100.00	\$1,045.00
80" / 2000mm	539-860	\$1,675.00	\$1,591.25

KA-200 DIGITAL COUNTER

Features:

- Excellent addition to manual machine retrofit packages.
- Many high-end functions packed into this standard counter.
- The large LED display is sharp and bright. Easy to see at a distance
- The positive touch front panel keys are solid and easy to push with fast response.
- The sub display lets you know what function you are currently using.



Features Included with purchase of AT715 Coolant Proof Linear Scale

ABSOLUTE® IP67



We're so confident in the exceptional performance of our AT-715 Series Coolant Proof Linear Scales that we offer a full 5 Year Warranty!

BRACKETS

	Description	Order No.	Price
Milling System	Universal bracket kit (12")	64AAB196	\$267.00
	Universal bracket kit (14-16")	64AAB197	\$275.00
	Universal bracket kit	64AAB198	\$297.00
	Screw Kit	64AAB199	\$58.00
Lathes	Bracket Kit	64AAB191	\$324.00
Grinders	Scale Y axis	64AAB194	\$451.00
All Systems	Machine arm kit (KA Counter)	64AAB200	\$226.00

SURFTESTS

SURFTEST SJ-310

Order No. 178-571-02A



PROMO
\$4,431.05 List Price \$5,213.00

SURFTEST SJ-411

Order No. 178-581-02A



PROMO
\$8,277.30 List Price \$9,738.00

SURFTEST SJ-500

Order No. 178-533-02A

PROMO
\$14,450.00
List Price \$17,000.00



Please view our online catalogue
for the full list of features
accessories and specifications



MICROSCOPES

TM-505B & TM1005B

Order No.	176-818A		176-819A
Objective lens	Standard accessory: 2X, Options: 5X, 10X		
Microscope head	Maximum height of workpiece	4.53"/115mm	4.21"/107 mm
illumination unit	Transmission Illumination Surface Illumination	Stepless bright adjustment, white LED light source, with green filter Oblique single-source type, Stepless brightness adjustment, White LED light source	
Cross-travel stage	Measuring Range	2" X 2" / 50 X50 mm	4" X 2" / 100 50 mm (Optional 2"/ 50 mm gauge block is required to cover full range. A CERA block is recommended.)
	Table size	6" X 6" / 152 X152 mm	9.44" X 6" / 240 X 152 mm
	Usable area of the stage glass	3.8" X3.8" / 96 X96 mm	6" X 3.8" / 152 X 96mm
Linear Measurement Method	Micrometer heads optional		
Resolution	.00005"/ 1µm		
Micrometer head travel range	2" / 50 mm		
	SAVE 15%	\$4,027.30	\$5,833.55
	Regular List	\$4,738.00	\$6,863.00



OPTIONAL ACCESSORIES

Description	Order No.	Price
MOTICAM 1080, 2.0 MEGAPIXEL-1/2.8" CMOS, USB/HDMI	64AAB526	\$1,445.00



DIGIMATIC MICROMETER HEAD

Order No.	Price	Calibration
164-164	\$984.30	\$76.00



Mitutoyo
MENTORSHIP WORKSHOPS



VISIT WWW.MITUTOYO.CA/WORKSHOPS TO REGISTER



10 Major Equipment

LASER SCAN MICROMETERS

With a wide variety of models, LSM Measurement can be utilized in diverse applications. The LSM-500S can measure ultra-fine wires as thin as .0002" (0.005mm) in diameter to a resolution of .000001" (0.00001mm) Options for measuring large diameters are available.



SAVE 15%

ON SELECT LASER MICROMETERS



Description	Order No.	Promo
Laser Scan Micrometer, LSM-500S, .0002-.08 / .005-2mm, High Accy, Non-Contact	544-532	\$7,533.55
Laser Scan Micrometer, LSM-501S, .002-.4" / .05-10mm, High Accy, Non-Contact	544-534	\$6,428.55
Laser Scan Micrometer, LSM-503S, .012-1.18" / 0.3-30mm, High Accy, Non-Contact	544-536	\$7,257.30
Laser Scan Micrometer, LSM-506S, .04-2.36" / 1-60mm, High Accy, Non-Contact	544-538	\$8,712.50
Laser Scan Micrometer, LSM-512S, .04-4.72" / 1-120mm, High Accy, Non-Contact	544-540	\$15,300.00

SOFTWARE

Software, LSMPAK, V2.0

Order No. 02NGA002

PROMO

\$1,881.05

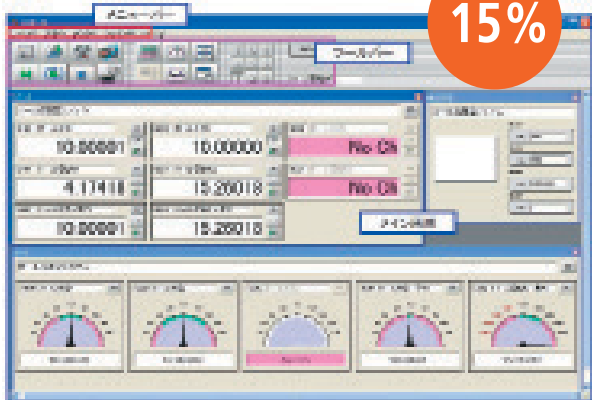

15%

DISPLAY

LSM-5200, Multi -Channel, Inch/Metric

Order No. 544-047

PROMO

\$3,187.50

LSM-6200, Inch/Metric

Order No. 544-072A

PROMO

\$3,485.00



15%

EVENTS

Canadian Manufacturing Technology

CMTS Mitutoyo Canada Booth #2530 - October 1- 4th

Mentorship Workshop - Gauge Calibration

Hosted by Mitutoyo Canada- December 5th, 2019



PROFILE PROJECTORS

PACKAGES

Description	Order No.	List Price	Promo
PH-3515F KA Counter PKG # 1	M172868-1	\$14,500.00	\$13,050.00
PH-3515F QM-DATA PKG # 2	M172868-2	\$16,875.00	\$15,187.50
PH-3515F QM-DATA/OPT200 PKG # 3	M172868-3	\$19,500.00	\$17,550.00

Description	Order No.	List Price	Promo
PH-A14 KA Counter PKG # 4	M172810-4	\$10,268.00	\$9,241.20
PH-A14 QM-Data PKG # 5	M172810-5	\$12,687.00	\$11,418.30
PH-A14 QM-Data w/OPT200 PKG # 6	M172810-6	\$14,197.00	\$12,777.30



PH-3515F



CHOOSE THE PACKAGE WITH THE OPTIONS YOU PREFER!



KA-200 DISPLAY COUNTER

- Simple to use 2 axis counter
- Inch/mm switchable
- Zero Set/Preset functions



QM DATA PROCESSOR

- Graphic display screen
- Programmable
- Full 2D coordinate measurement capability



OPTOEYE-200 EDGE SENSOR

- Eliminates visual alignment errors
- Ensures fast, accurate and consistent measurements



PH-A14



* WITH TOUCH SCREEN

PROFILE PROJECTOR PH-A14 M2 D2 PROCESSOR AND RETROFIT PACKAGES

Non-Edge Detection Unit, M2 Software/Hardware, Mounting Kit ASUSPRO A4110-XS02, All-In-One PC, PH-A14

Order No. 64PKA154

List Price \$13,505.00

PROMO

\$12,154.50

Optical Edge Detection Unit, M2 Software/Hardware, Mounting Kit ASUSPRO A4110-XS02, All-In-One PC, PH-A14

Order No. 64PKA155

List Price \$15,273.00

PROMO

\$13,745.70

Retrofit Packages Non-Edge Detection Unit, M2 Software/Hardware, Mounting Kit ASUSPRO A4110-XS02, All-In-One PC, PH-A14

Order No. 64PKA156

List Price \$5,179.00

PROMO

\$4,661.10

Retrofit Packages Optical Edge Detection Unit, M2 Software/Hardware, Mounting Kit ASUSPRO A4110-XS02, All-In-One PC, PH-A14

Order No. 64PKA157

List Price \$6,958.00

PROMO

\$6,262.20





[VIEW FLYER](#)

CAPITAL EQUIPMENT PROMOTION

EFFECTIVE SEPTEMBER 1ST TO DECEMBER 20TH, 2019

MANUAL CMM | CNC CMM | VISION | SOFTWARE | ACCESSORIES

CONTACT YOUR MITUTOYO SALES REPRESENTATIVE DIRECTLY TO LEARN MORE
OR CONTACT US AT [INFO@MITUTOYO.CA](mailto:info@mitutoyo.ca)



Mitutoyo

We reserve the right to change prices and specifications without notice.
Not valid with any other offer or promotion. This promotion is for Canadian market only.
Request formal quotation for complete details.

Note: All information regarding our products, and in particular the illustrations, drawings, dimensional and performance data contained in this printed matter as well as other technical data are to be regarded as approximate average values. We reserve the right to make changes to the corresponding designs. The stated standards, technical regulations, descriptions and illustrations of the products were valid at the time of printing. In addition, the products are subject to Canadian Export Administration Regulations. Re-export or relocation of Mitutoyo products may require prior approval by an appropriate governing authority. We have tried to be as accurate as possible, however, there may be some errors in text, specifications or price. Please confirm with your customer service rep. Some items may not be exactly as shown. Prices are in Canadian dollars, unless otherwise specified. Applicable taxes and shipping charges are extra. © 2018 Mitutoyo Canada Inc., Mississauga ON Canada. We reserve the right to change specifications and prices without notice.

