



INDUSTRIAL INC.

an MSC Company

Toronto | Montréal | Edmonton

www.kar.ca

# SPRING INTO SAVINGS

## **YG** Spade Drill Inserts TiN | TiAlN | HARDSLICK

### 20% OFF ALL YG-1 SPADE DRILL INSERTS

\*BUY 2 OR MORE SPADE DRILLS AND RECEIVE A  
FREE 6 INCH POCKET RULE  
Valid from April 1-30, 2024 ONLY

Starting at...  
**35.36**



\*FREE 6 INCH POCKET RULE



VISIT WWW.KAR.CA FOR ALL DIMENSIONS



## Self-Starting Step Drills High Speed Steel



- 13 Steps | Ø range 1/8 to 1/2" .....Code 754700 **50.35**
- 6 Steps | Ø range 3/16 to 1/2" .....Code 754701 **41.60**
- 9 Steps | Ø range 1/4 to 3/4" .....Code 754702 **65.52**
- 12 Steps | Ø range 3/16 to 7/8" .....Code 754703 **87.83**

## Tap & Drill Set

18 Pieces | Black & Gold



Code 750007

**182.23**

- Heavy duty drills have gold treatment for maximum lubricity and torsional strength
- Sizes included:  
135° Split Point Drills: 5/16", 27/64", #7, #21, #25, #29, #36, F and U  
Spiral Point Taps: 6-32, 8-32, 10-24, 10-32, 1/4-20, 5/16-18, 3/8-16, 7/16-14 and 1/2-13 in metal indexed storage case

## **YG** Gold-P Drill Set High Speed Steel TiN Coated

- 1/16" x 1/2" by 64ths
- 135° split point
- Straight shank
- Right hand spiral wide flutes
- Supplied in indexed metal case



Code 883345

**159.56**

YOUR AUTHORIZED KAR DISTRIBUTOR:

## **TECHNICUT** INDUSTRIAL SUPPLY INC.

Unit 201-9466 189th Street, Surrey, B.C. V4N 4W7

**604.888.4052 Email: sales@technicut.ca**

# SPRING INTO SAVINGS

## Tiny Tool Set Solid Carbide Grade BXC



- For working on small bores
- Bar diameter: 4mm
- PVD TiN coated grade for low cutting speed
- Works well with a wide range of steel and stainless steel

**Complete Set Includes:** Boring bar 570093, profiling bar 570071, threading bar 570078, chamfering bar 570084, grooving bar 570088, face grooving bar 570091, bar holder 570104, and a Torx®15 key

Code 570110

**405.44**

## CNC Spotting Drills HSS-E Cobalt - Uncoated & RED-X Coated



- 90° angle
- 118° point geometry for improved penetration rates while reinforcing the point
- Double ended for cost savings
- RED-X coating provides increased speeds and feeds and allows machining up to 55 HRC

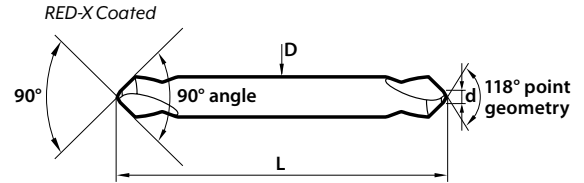

D (Inch)	d (Inch)	L (Inch)	90° Series 019 HSS-E COBALT		90° Series 0919 RED-X COATED	
			Code	Price	Code	Price
3/16	1/16	2	540091	11.37	540096	14.98
1/4	3/32	2	540092	12.07	540097	17.07
3/8	9/64	3	540093	18.88	540098	30.65
1/2	3/16	4	540094	29.23	540099	39.91

## IG Pipe Taps

High Speed Steel | Straight Flute | Spiral Flute



### HSS – Straight Flute



- For cast iron and steel applications
- NPT and NPTF standards

### HSSE-V3 – Spiral Flute



- For cast iron, steel and stainless steel applications
- NPT and NPTF standards
- High speed steel substrate with cobalt and 3% vanadium content for cutting stainless steels up to 29 HRC and tool steels up to 35 HRC

Size (Inch)	Threads per Inch	No. of Flutes	Overall Length (Inch)	Thread Length (Inch)	STRAIGHT FLUTE		SPIRAL FLUTE	
					Code	Price	Code	Price
1/16	27	4	2-1/8	0.688	915700	23.18	915716	28.38
1/8	27	4	2-1/8	0.750	915701	25.41	915717	31.37
1/4	18	4	2-7/16	1.063	915702	27.62	915718	34.96
3/8	18	4	2-9/16	1.063	915703	35.10	915719	44.98
1/2	14	4	3-1/8	1.375	915704	39.27	915720	52.45
3/4	14	5	3-1/4	1.375	-	-	915721	81.51
1	11-1/2	5	3-3/4	1.750	915706	96.55	915722	129.28
1-1/4	11-1/2	5	4	1.750	915707	151.66	915723	205.51
1-1/2	11-1/2	7	4-1/4	1.750	915708	230.98	915724	309.17
2	11-1/2	7	4-1/2	1.750	915709	378.40	915725	309.17

## Indexable Spotting Drill Sets with Carbide Inserts



- One combination tool that does four applications, giving extra efficiency and reduced cycle times
- For spotting, engraving, chamfering and grooving on CNC and conventional milling machines
- For spotting on CNC lathes
- Indexable carbide inserts with 4 cutting edges provides great cost per edge and long tool life
- Insert fits both 1/2" and 5/8" diameter tools

1/2" x 4" Steel Holder  
6 inserts | Torx® 15 key  
Code 530659

**170.77**

5/8" x 4" Steel Holder  
6 inserts | Torx® 15 key  
Code 530656

**173.84**

5/8" x 4" Stainless Steel Holder  
6 inserts | Torx® 15 key  
Code 530657

**173.84**

# SAVE AT KAR

## Hand Deburring

**SHAVIV** Exclusively Available at **KAR** in Canada 

### Standard & Heavy Duty Sets

- Popular for deburring holes, slots and edges
- Mango II handle provides maximum comfort
- Deburrs steel, aluminum, copper, brass, cast iron, stainless steel and plastics



Shown with Holder B and B10 blade  
Mango II Handle  
Blades can be inserted axially or perpendicular with holder B

### Mango IIB + 2 Extra Close Standard B

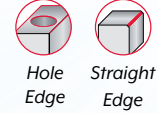

Code 550602  
**10.50**

**INCLUDES:** 2 HSS standard B blades - B10, B20 |  
Mango IIB ergonomic handle with safety lock

### Set B | The Workhorse

Set B with Mango II Handle  
Holder B, Blades: B10, B20  
Code 550600

**20.36**

### Set E | Heavy Debur

Set E with Mango II Handle  
Holder E, Blades: E100, E200, E300  
Code 550601

**23.27**

### Mango IIE + 3 Extra Close Heavy Duty E

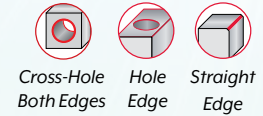

Code 550603 **13.04**

**INCLUDES:** 3 HSS heavy duty E blades - E100, E200, E300 |  
Mango IIE ergonomic handle with safety lock

### Mango II Set M

- Deburrs holes, slots and edges of steel, aluminum, copper, brass, cast iron, stainless steel, and plastics
- Mango II handle for maximum comfort
- Holder M supports both B and E blades



Mango II Set M | Code 550605

**28.63**

### Mango II Set D - The Sheet Cleaner

- Perfect for sheet metal up to 0.12" thick (3mm)
- Blade deburrs both sides of sheet in one pass
- Blade also functions as a surface cleaner
- Mango II handle provides maximum comfort
- For added safety use with handguard (Code 550815)
- Deburrs steel, aluminum, copper, brass, cast iron, hardened steel and plastics

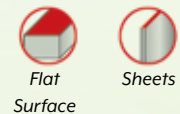

Mango II Set D | Code 550607

**28.53**

### Blades



High Speed Steel  
B10 | Code 550832

**1.38**

High Speed Steel  
B20 | Code 550838

**1.38**

High Speed Steel  
B30 | Code 550840

**2.76**

High Speed Steel  
E100 | Code 550858

**1.74**

High Speed Steel  
E200 | Code 550860

**1.74**

High Speed Steel  
E300 | Code 550862

**2.90**

Solid Carbide  
D80C | Code 550852

**12.66**



# SPRING INTO SAVINGS

## Universal 3-Jaw Lathe Chucks Plain Back Series 3205

Cast Iron Body with 2-Piece Jaws | Self-Centering



- Cast iron
- Plain back (Back plates required)
- Ground working surfaces

### Standard Accessories:

- 1 set of hard top jaws
- 1 set of hard master jaws
- 1 wrench
- 1 hex key

5 Inch  
Code 355000

**1147.48**

6 Inch  
Code 355001

**1222.41**

8 Inch  
Code 355002

**1489.19**

12 Inch  
Code 355004

**2795.65**

10 Inch  
Code 355003

**2002.62**

16 Inch  
Code 355005

**5368.36**

ALL DIMENSIONS AT [WWW.KAR.CA](http://WWW.KAR.CA)

## Dead Centers with Nut

Solid Centers | Alloy Steel

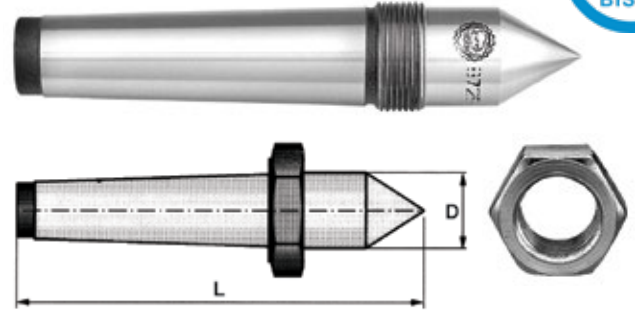

Morse Taper	L (Inch)	D (Inch)	Spare Nut Reference		DEAD CENTER WITH NUT	
			Size (Inch)	Spare Nut Code	Code	Price
1	3.54	0.48	0.94	826335	826323	<b>86.71</b>
2	4.41	0.71	1.26	826336	826324	<b>101.81</b>
3	5.43	0.95	1.61	826337	826325	<b>124.44</b>
4	6.89	1.24	2.17	826338	826326	<b>179.08</b>
5	8.54	1.76	-	-	826327	<b>256.39</b>
6	11.42	2.51	3.94	826340	826328	<b>522.22</b>

## Steel Serrated Soft Jaws | 3-Piece Sets

Extra Height

For Chuck Diameter	S3 (mm)	Code	Price
6"	50	302323	<b>68.78</b>
6"	80	302324	<b>115.67</b>
8"	50	302325	<b>78.42</b>
8"	80	302326	<b>128.49</b>
10"	90	302328	<b>170.44</b>
10"	120	302329	<b>216.57</b>
12"	80	302331	<b>198.73</b>
12"	100	302333	<b>229.93</b>
12"	120	302335	<b>262.54</b>
12"	80	302330	<b>198.73</b>
12"	100	302332	<b>229.93</b>
12"	120	302334	<b>262.55</b>
15"	80	302336	<b>295.56</b>
15"	130	302338	<b>475.62</b>
15"	80	302337	<b>295.56</b>
15"	130	302339	<b>475.62</b>
15"/18"	150	302340	<b>634.56</b>
18"	150	302322	<b>634.56</b>

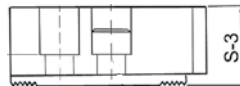

FOR MORE  
STYLES AND  
ALL SOFT JAW  
DIMENSIONS  
VISIT [KAR.CA](http://KAR.CA)



1.5x 60° Standard Type | Extra height

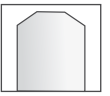

Standard Type

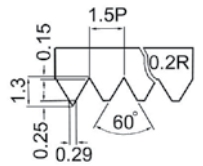

## Lathe Chuck Grease

16 oz. Can

- For manual and power chucks, fasteners, press fits, wear-in guides and ways

Code 355326

**49.74**



# SAVE AT KAR

## ER Collet Sets

Inch | Supplied in Fitted Storage Case

Collet Size	INCH		
	Pieces /set	Code	Price
ER16	7	826617	145. <sup>28</sup>
ER20	10	826618	209. <sup>48</sup>
ER25	12	826619	273. <sup>01</sup>
ER32	11	826620	262. <sup>42</sup>
ER40	15	826621	701. <sup>39</sup>



## Tightening Fixtures

Universal Horizontal / Vertical  
CNC Tool Tightening Fixtures

Taper Size 40  
Code 310842

265.<sup>31</sup>

Taper Size 50  
Code 310843

288.<sup>47</sup>



Mount vertically and/or horizontally



ALL DIMENSIONS AT WWW.KAR.CA



BUY ANY CAT40 COLLET CHUCK FROM THIS FLYER  
BETWEEN MAY 1-31, 2024 ONLY AND RECEIVE A  
FREE FOLDING MAGNIFIER WITH LIGHT

## ER Collet Chucks

CAT40

- Constructed of high quality alloy steel - SAE8620/20MnCR5
- Taper to taper runout: <0.0002"
- Coolant through spindle
- CAT40 balanced G2.5@20,000 RPM
- Balanced tools supplied with QA certificates
- Supplied with depth set screws
- Supplied with high torque hard coat power nuts
- Taper shank ground to AT3 accuracy or better
- DIN AD+B flange coolant

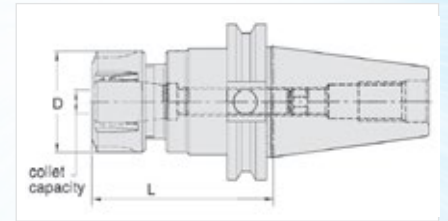

NOTE: Collet wrench sold separately

Collet Series	Collet Cap Min-Max (Inch)	Nut	D (Inch)	L (Inch)	CAT40		
					Weight (lbs)	Code	Price
ER11	0.02-0.28	Hex	0.79	2.50	2.0	300681	76. <sup>31</sup>
	0.02-0.28		0.79	4.00	2.2	300682	80. <sup>55</sup>
	0.02-0.28		0.79	6.00	2.4	300683	88. <sup>62</sup>
ER16	0.02-0.41		1.10	2.50	2.4	310965	76. <sup>31</sup>
	0.02-0.41		1.10	4.00	3.2	310966	80. <sup>55</sup>
	0.02-0.41		1.10	5.00	3.2	310967	88. <sup>62</sup>
ER20	0.02-0.50		1.34	2.50	2.4	310968	76. <sup>31</sup>
	0.02-0.50		1.34	4.00	3.5	310969	80. <sup>55</sup>
	0.02-0.50		1.34	6.00	3.7	310970	88. <sup>62</sup>
ER25	0.04-0.63	1.65	2.50	2.6	310971	76. <sup>31</sup>	
	0.04-0.63	1.65	4.00	4.5	310972	80. <sup>55</sup>	
	0.04-0.63	1.65	6.00	4.4	310973	88. <sup>62</sup>	
ER32	0.04-0.81	Round	1.97	2.75	2.6	310974	76. <sup>31</sup>
	0.04-0.81		1.97	4.00	6.8	310975	80. <sup>55</sup>
	0.04-0.81		1.97	6.00	4.4	310976	88. <sup>62</sup>
ER40	0.12-1.00		2.48	3.00	3.0	310977	76. <sup>31</sup>
	0.12-1.00		2.48	6.00	3.0	310978	88. <sup>62</sup>

# SPRING INTO SAVINGS

## INSIZE TOOLS THAT MEASURE UP

### Telescoping Magnetic Pick-Up and Flashlight

INSIZE

**NEW**

16.<sup>83</sup>

- Flashlight range: 118"
- For illumination and pick up metal parts in hidden areas
- Head can bend
- Telescoping handle, made of stainless steel
- Magnetic head and end
- With four LR44 batteries
- Battery life: 8h

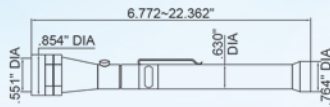

Magnetic Force of End (lbf)	Magnetic Force of Head (lbf)	Length (Inch)	INSIZE No.	Code
8	4.6	6.772-22.362	7163-1	877410

### Telescoping Magnetic Pick-Up

INSIZE

**NEW**

15.<sup>41</sup>

- Pick up metal parts from hidden areas
- Rotation of the magnetic head: 360°
- Length of handle is adjustable
- Handle made of brass and chrome plated

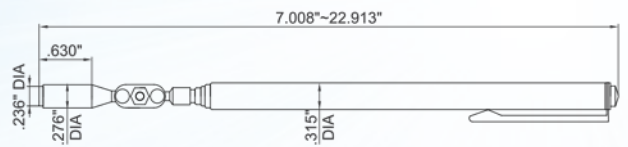

Magnetic Tip (Inch)	Magnetic Force	Length (Inch)	INSIZE No.	Code
Ø0.236	0.99lbf	7.008-22.913	7161-1	877206

### Electronic Calipers

INSIZE

#### Standard Model



OPTIONAL ACCESSORY: SPC cable

- Resolution: 0.0005"/0.01mm
- Buttons: on/off, zero, inch/mm
- Auto power off, move digital unit to turn power on
- Battery CR2032
- Data output
- Stainless steel construction
- Supplied in fitted storage case

0-6 Inch/0-150mm  
Accuracy: ±0.0010"  
Code 817000

56.<sup>36</sup>

0-8 Inch/0-200mm  
Accuracy: ±0.0015"  
Code 817001

77.<sup>72</sup>

0-12 Inch/0-300mm  
Accuracy: ±0.0015"  
Code 817002

136.<sup>44</sup>

#### Absolute

- Absolute system
- Resolution: 0.0005"/0.01mm
- Buttons: Inch/mm, ABS/REL, on/off, origin set
- Battery CR2032
- Auto power off
- Data output
- Stainless steel
- Supplied in fitted storage case

0-6"/0-150mm  
Code 285127

76.<sup>73</sup>

0-8"/0-200mm  
Code 285128

107.<sup>81</sup>

0-12"/0-300mm  
Code 285129

192.<sup>98</sup>

#### Zinc Alloy Casing



- Resolution: 0.0005"/0.01mm
- Zinc alloy casing
- Buttons: zero, on/off, inch/mm
- Auto power off
- Battery CR2032
- Stainless steel construction
- Supplied in fitted storage case

0-6 Inch/0-150mm  
Accuracy: ±0.0015"  
Code 816012

80.<sup>01</sup>

0-8 Inch/0-200mm  
Accuracy: ±0.0015"  
Code 816014

107.<sup>72</sup>

0-12 Inch/0-300mm  
Accuracy: ±0.0015"  
Code 816016

186.<sup>17</sup>

OPTIONAL ACCESSORY: SPC cable

BUY \$200 OF INSIZE PRODUCTS AND RECEIVE A FREE HAT. VALID FROM JUNE 1-28, 2024



# SAVE AT KAR

## ←INSIZE→ TOOLS THAT MEASURE UP

### Vernier Calipers

- Graduations: 0.001"/0.02mm
- Accuracy: ±0.0012"
- Stainless steel with satin chrome plated reading surface
- Supplied in fitted storage case



0-6 Inch/0-150mm  
Code 876750

55.<sup>31</sup>

0-8 Inch/0-200mm  
Code 876225

87.<sup>93</sup>

0-8 Inch/0-200mm  
Code 876232

155.<sup>35</sup>



### Dial Calipers



- Graduations: 0.001"
- One revolution equals: 0.1"
- Shock proof dial indicator
- Supplied in fitted storage case

0-4 Inch  
Accuracy: ±0.0012"  
Code 280462

90.<sup>61</sup>

0-6 Inch  
Accuracy: ±0.0015"  
Code 816028

79.<sup>70</sup>

0-8 Inch  
Accuracy: ±0.0020"  
Code 816030

105.<sup>55</sup>

0-12 Inch  
Accuracy: ±0.0020"  
Code 816032

193.<sup>12</sup>

### Dial Indicators



- ASME B89.1.10M-2001 standards
- Graduation: 0.001"
- First 2.5 rev. accuracy: ±0.001"
- Range per rev.: 0.1"
- Dial reading: 0-100
- Lug back
- Bezel locking clamp and limit pointers
- Contact point thread: #4-48UNF
- Supplied in fitted storage case



816158

OPTIONAL ACCESSORIES: Contact points, Flat back

1 Inch  
Accuracy: ±0.002"  
Code 816158

41.<sup>38</sup>

2 Inch  
Accuracy: ±0.004"  
Code 816160

97.<sup>48</sup>

### Dial Test Indicators



- Jeweled bearing
- Carbide contact point
- Two measuring directions
- Anti-magnetic body
- Supplied with two clamps: 5/32" and 3/8" diameters
- Supplied in fitted storage case



Supplied with two clamps

OPTIONAL ACCESSORY:  
Contact point (stylus) - series 6284

0.03 Inch  
Graduation: 0.001"  
Accuracy: ±0.001"  
Dial reading: 0-15-0  
Code 282858

90.<sup>75</sup>

0.03 Inch  
Graduation: 0.0005"  
Accuracy: ±0.0005"  
Dial reading: 0-15-0  
Code 816170

118.<sup>68</sup>

0.008 Inch  
Graduation: 0.0001"  
Accuracy: ±0.0001"  
Dial reading: 0-40-0  
Code 816172

158.<sup>16</sup>

0.03 Inch  
Graduation: 0.001"  
Accuracy: ±0.001"  
Dial reading: 0-15-0  
Code 282859

93.<sup>77</sup>

0.03 Inch  
Graduation: 0.0005"  
Accuracy: ±0.0005"  
Dial reading: 0-15-0  
Code 282860

95.<sup>91</sup>

0.008 Inch  
Graduation: 0.0001"  
Accuracy: ±0.0001"  
Dial reading: 0-40-0  
Code 282861

158.<sup>82</sup>

### Measuring Tool Set



Caliper, Micrometer & Rule

284514

150.<sup>23</sup>

- Set Includes:
  - 1) Electronic caliper (INSIZE #108-150), range 0-6"/0-150mm, resolution 0.0005"/0.01mm
  - 2) Outside micrometer (INSIZE #3202-1), range 0-1", graduation 0.0001"
  - 3) Rule (INSIZE #7110-150), 0-6"/0-150mm, graduations – inch: 1/32", 1/64" and 1/16", metric: 0.5mm and 1mm, made of flexible stainless steel
- Supplied in fitted storage case



BUY \$200 OF INSIZE PRODUCTS AND RECEIVE A FREE HAT. VALID FROM JUNE 1-28, 2024



# SPRING INTO SAVINGS

## Collet Chuck Quick Change Adapter

1/8-1" Capacity | No. 40 Taper

Code 302196

299.24



## Dead Blow Hammers

Steel construction with steel shot



- One piece steel construction with steel shot
- Polyurethane coated thermoplastic rubber – no exposed metal on head or handle
- Textured non-slip handle with flanged end for a comfortable and safe grip
- Hammer hardness: 90A-95A

	18 oz.	24 oz.	
	Code 284560	Code 284561	
	26.38	29.57	
33 oz.	41 oz.	49 oz.	
Code 284562	Code 284563	Code 284564	
36.87	42.17	49.85	

## Fixed Bench Vises

- Graded cast iron body
- Hardened and ground alloy steel jaws
- Perfectly aligned vise for smooth functioning

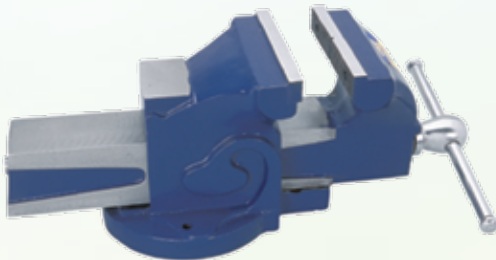

3 x 3-3/8 Inch Opening Code 416250	4 x 4 Inch Opening Code 416251	5 x 5 Inch Opening Code 416252	6 x 6 Inch Opening Code 416253
71.26	108.13	144.25	214.10

## Oil Cans

- Compact and robust
- Metal body with brass pump
- Supplied with rigid and flex spouts

Pump Style



300 ml | Code 416300

12.18

500 ml | Code 416301    700 ml | Code 416302

12.94

16.18

## Power Table Feed

- Smooth running with high torque maximum of 650 in/lb
- New and stronger design assures long trouble-free life
- Electrical and mechanical parts are designed for easy maintenance

Specifications:

Voltage: 110V, 50/60Hz  
Speed Range: 4-160 RPM  
Rapid Speed: 200 RPM  
Max. Torque: 650 lbs/in  
Dimensions:  
290 x 200 x 320mm



X-Axis | Code 302235    Y-Axis | Code 302234

1033.75

1085.60

## Marking Pens

DYKEM

General Purpose (12 cc) with Patented Valve-Action



8.68/ea.

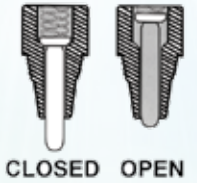

DYKEM pens are designed with a patented valve-action feature. Even when the cap is left off for a period of time, the tip can be recharged simply by pressing it against a surface, allowing the ink to flow from the reservoir. **Black** - Code 219077 | **White** - Code 219078 | **Yellow** - Code 219079 | **Red** - Code 219080 | **Blue** - Code 219081 | **Orange** - Code 219082 | **Green** - Code 219083

## Sharpening Stones

Aluminum Oxide & Silicon Carbide

- Coarse 120 grit and fine 150 grit in one
- Size: 1" x 2" x 6"



Aluminum Oxide ..... Code 604230  
Silicon Carbide..... Code 604231

10.21/ea.

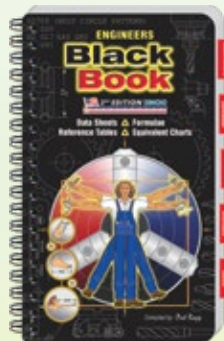

## Engineer's Black Book

3rd Edition

- Pocket size with 234 laminated, non-glare, tear and grease proof pages
- Non-slip rubberized cover
- Wired lay flat binding
- Self adhesive bookmark tabs

Code 284998

51.87



**KAR Industrial Inc.**  
[www.kar.ca](http://www.kar.ca)

Toronto.....1-800-387-3127  
Montréal.....1-800-363-7862  
Edmonton.....1-866-440-4326

Offer valid until June 28, 2024

\*Products shown may not be exactly as illustrated    Code 000336

MAKING IT EASY TO DO BUSINESS WITH SINCE 1954... CONTACT YOUR LOCAL KAR DISTRIBUTOR TODAY!